

## Installation Instructions

### RTES End Seal Kit for Self-Regulating and Constant Wattage Heating Cable

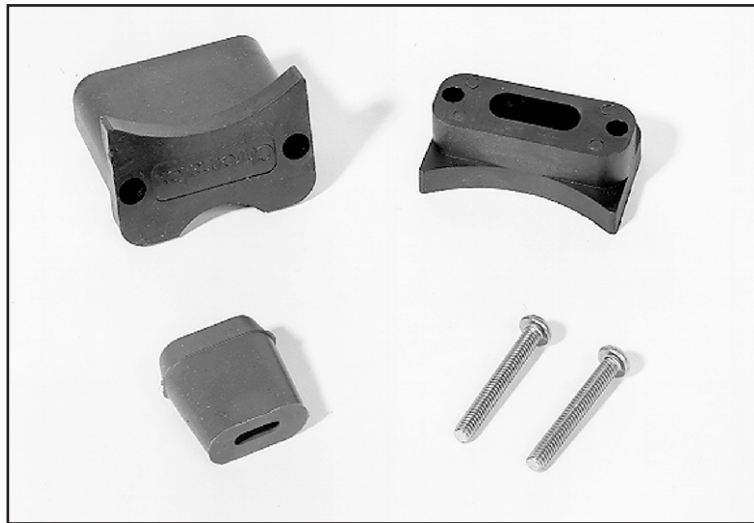

**RTES End Seal Kit Parts:**

- 1 - End Cap
- 1 - Pressure Plate
- 2 - Screws
- 1 - Sealing Grommet for Self-Regulating Cable

**Certifications & Approvals**

- UL listed Ordinary Areas
- FM approved Ordinary Areas
- Class I, Division 2, Groups B, C, D
- Class II, Division 2, Groups F, G
- Class III, Division 2



RTES for use only with Trasor SRL and SRME Self Regulating heating cables

## GENERAL

The RTES kit is used for terminating braided (-C) and overjacketed (-CR or -CT) versions of Self Regulating and Fluoropolymer insulated Constant Wattage Heating Cable.

Each kit contains enough material to make one termination. Materials required include: sharp utility knife, standard electrical cutters, screwdriver and fiberglass tape.

## INSTALLATION

**WARNING: Hazard of Electric Shock. Disconnect all power before starting. All installations must be effectively grounded in accordance with the National Electrical Code to eliminate shock hazard.**

**Note:** All electrical wiring, including GFCI (Ground Fault Circuit Interrupters), must be done in accordance with the National Electrical Code and local codes by a qualified person.

**Note:** These instructions are for all Self-Regulating and Constant Wattage heating cables in ordinary locations. Consult factory for installation of braided cable in hazardous locations. Not all instructions, are for all cables. Each step has a boldface heading stating what type of cable that instruction is for.

**1. FOR CONSTANT WATTAGE CABLE:**

Using standard electrical cutters, make a perpendicular cut across the cable four inches from the last module point.

**Note:** Cutting the cable between module points (indentions in cable) creates a non-heated cold lead. See Figure 1.

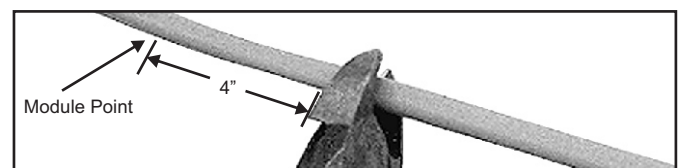

**Figure 1**

## INSTALLATION

### 2. FOR CABLE WITH EXPOSED METAL BRAID (-C):

Push the braid back three inches to expose the base cable insulation. See Figure 2.

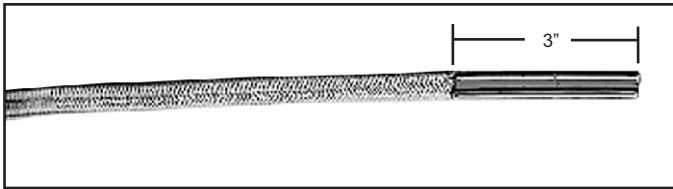

Figure 2

### 3. FOR ALL CABLE:

Slide the pressure plate and grommet over the end of the cable. Note: The pressure plate and end cap have different size curved surfaces on the top and bottom of each piece. These curved surfaces are designed to give a better fit on process equipment. The side with the smaller radius curve is for use on pipes with diameters up to three inches or on flat surfaces. The other side is for use on pipes with diameters of three inches or more. See Figure 3 and Figure 8.

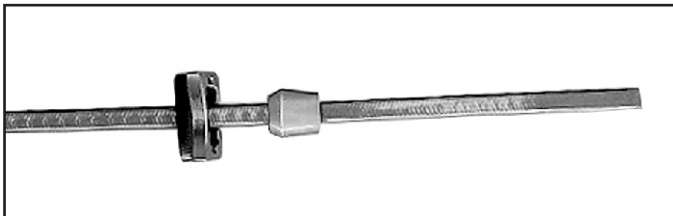

Figure 3

### 4. FOR OVERJACKETED CABLES (-CR or -CT):

Score the overjacket one inch from the end of the cable. Remove the jacket to expose the braid. Unravel and trim the braid flush with the overjacket. Pull any strands of braid back towards the outer jacket. See Figure 4.

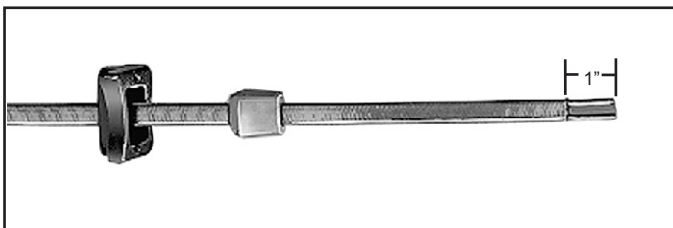

Figure 4

### 5. FOR ALL CABLE:

Using standard electrical cutters, cut a "VEE" notch between the buss wires. See Figure 5.

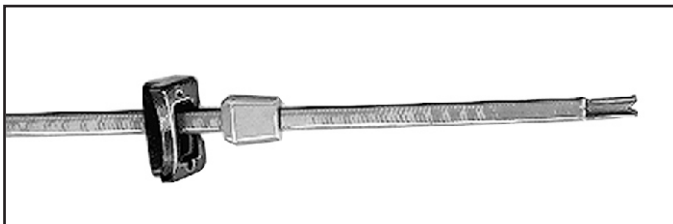

Figure 5

### 6. FOR ALL CABLE:

Slide the pressure plate and grommet towards the end of the cable leaving 5/8" of the cable extending past the end of the grommet. See Figure 6.

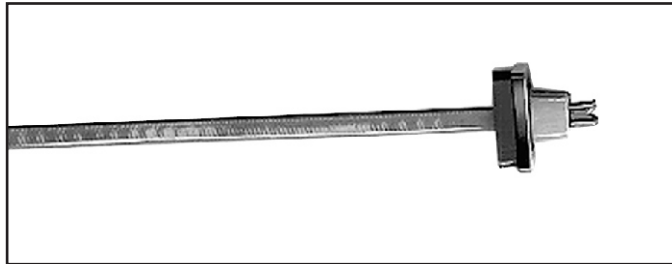

Figure 6

### 7. FOR ALL CABLE:

Slide the end cap over the grommet. Using a screwdriver, connect the pressure plate to the end cap. See Figure 7.

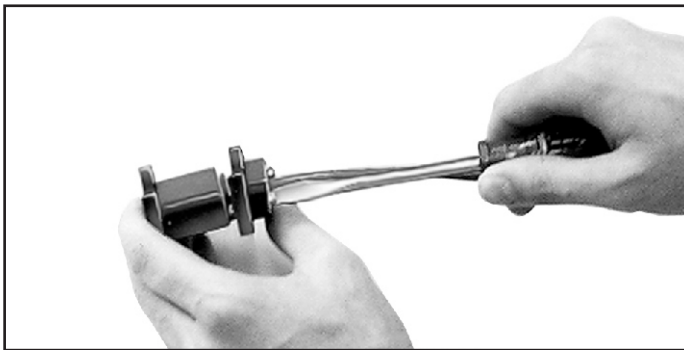

Figure 7

### 8. FOR ALL CABLE:

Using a fastening device, fiber re-inforced electrical tape (Trasor FGT-180 or equal), secure the assembly to the pipe. Wrap the tape around the assembly between the legs. See Figure 8.



Figure 8